

## Heated Hoses

Heat meter for meter

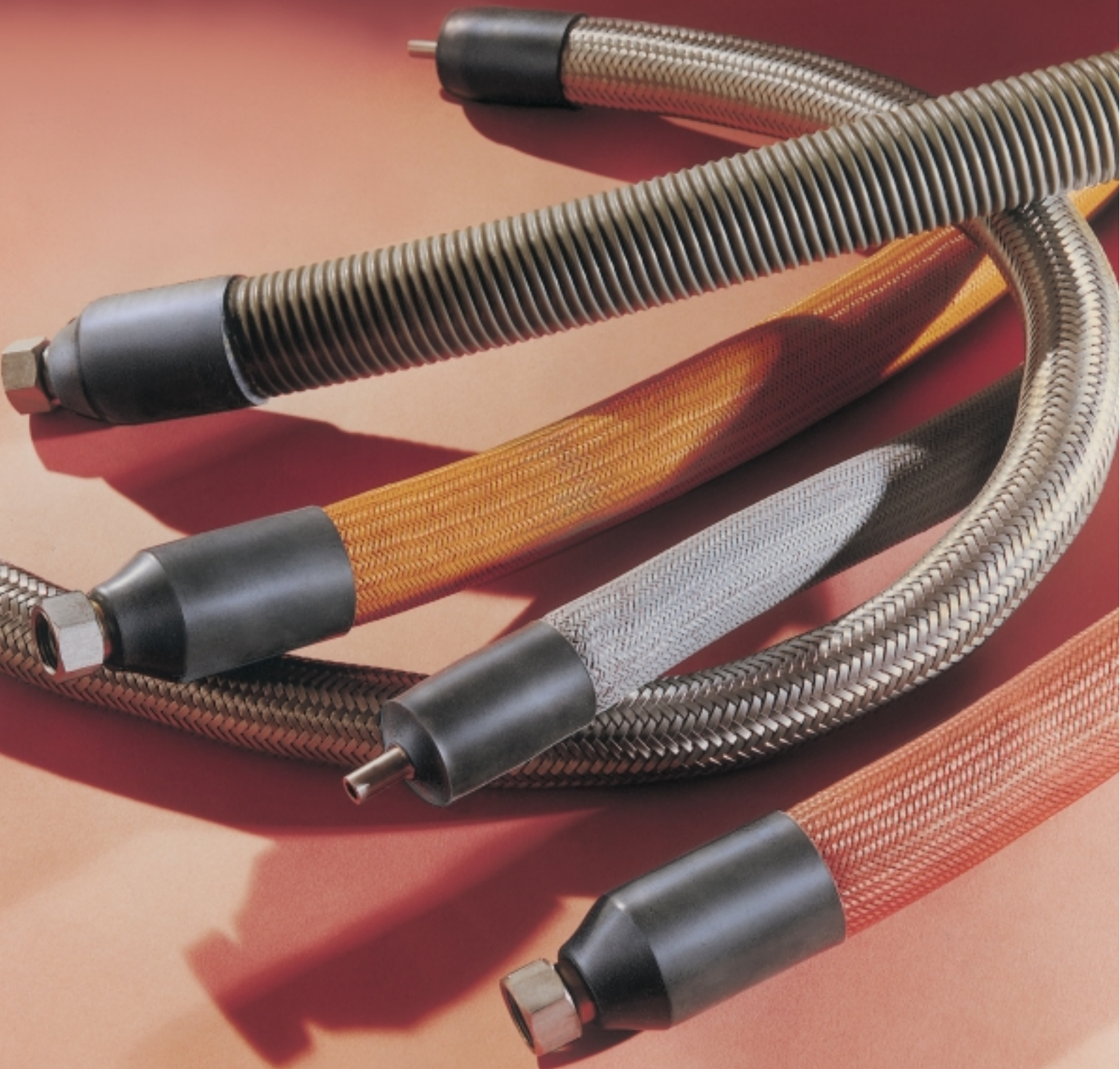

## Heated hoses

Isopad heated hoses are designed to be used in a variety of industrial applications, for example as fire-extinguishing lines for tanker vessels or for feeding liquid or viscous products to on-line or robot workstations. Owing to their resistance to high temperatures, pressures, and aggressive materials the hoses enable substances to be transferred within a factory plant where the use of fixed lines with constant temperature control is impossible.

CONTENTS	Page
What are heated hose systems? .....	3
Possible ranges of application, construction of a heated hose .....	4
Notes on technical design rating .....	5
Hose connections .....	7
<b>Product data</b>	
IHH 105 type .....	8
IHH 203 type .....	9
IHH 205 type .....	10
Fittings for the IHH 105, IHH 203, IHH 205 types .....	11
IHH 380 type .....	13
Fittings for the IHH 380 type .....	14
Heated hoses for gas analysis .....	16
IHA type heated hoses in cut-off design .....	17
Heated hoses specifications sheet .....	19

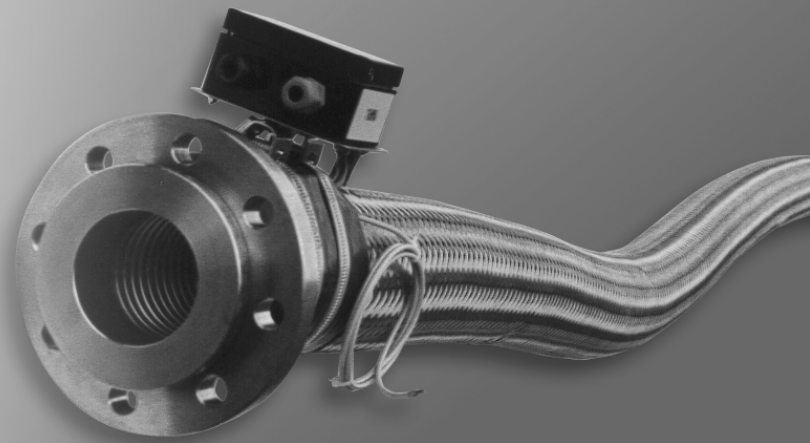

## What are heated hoses?

### Heated hoses are used in:

- PUR form plants
- Wax-processing plants
- Bitumen spraying and processing plants
- Cold-glue application plants (labelling plants)
- Hot-glue application plants and devices (Hotmelt)
- Heavy-oil lines
- Gas-analysis plants
- Food-processing plants etc.

### in order to

- keep media free-flowing for processing, and attain their optimum properties
- avoid condensation in the case of gaseous media
- rationalise processing while maintaining uniform quality levels
- enable production and measurements without restrictions as to the site
- link mobile components of equipment and plants

Listing all the possible applications here would go beyond the scope of this paper. Should you need a solution for a particular problem, we would be pleased to cooperate with you in working out a suitable heated hose concept.

The basis of any flexible heated hose system is formed by the inner hose carrying the liquid or gaseous medium.

As a rule, our standard hoses are provided with a high-quality PTFE inner hose which is resistant to almost all media. It's withstand temperature ranging from  $-70^{\circ}\text{C}$  to  $+250^{\circ}\text{C}$  covers a wide range of possible applications. However, other materials may be used to manufacture hoses for special applications, should this be required by the customer's specifications or by particular operational or environmental conditions. In this context a general distinction is made between applications in the pressurized and non-pressurized sector.



The operating pressure and the operating temperature are a direct function of each other. Owing to the fact that the withstand pressure of the PTFE inner hose is limited at high pressures, it is provided with a stainless steel armouring which increases the pressure resistance significantly. (Please refer to page 6, T1, T2, T3 pressure table.)

## 50 years of experience in top quality

Tyco Thermal Controls has more than 50 years of experience in project planning and manufacturing heated hose systems. Since 1946, Isopad has been improving and further developing heated hoses on a continuous basis.

Isopad heated hose systems are manufactured exclusively from top-quality materials, and our certified Quality Assurance system meets the highest standards imposed in terms of lifetime and precision. The customer will benefit from minimum production downtimes.

Tyco Thermal Controls' world-wide presence guarantees an ever available customer service on a global basis. For spare-part orders, simply contact your local distribution office.

### Possible applications for heated hoses

Wherever liquid or gaseous media need to be transferred from one component of a device or plant to another at a temperature above ambient and the use of fixed lines is impossible, heated hose systems offer themselves as a carrier element.

The hose's heating prevents, for instance, changes in the product viscosity or the formation of condensate in the case of gaseous media.

Most applications require the product temperature to be held at a preset value, regardless of temperature fluctuations occurring in the plant or the environment.

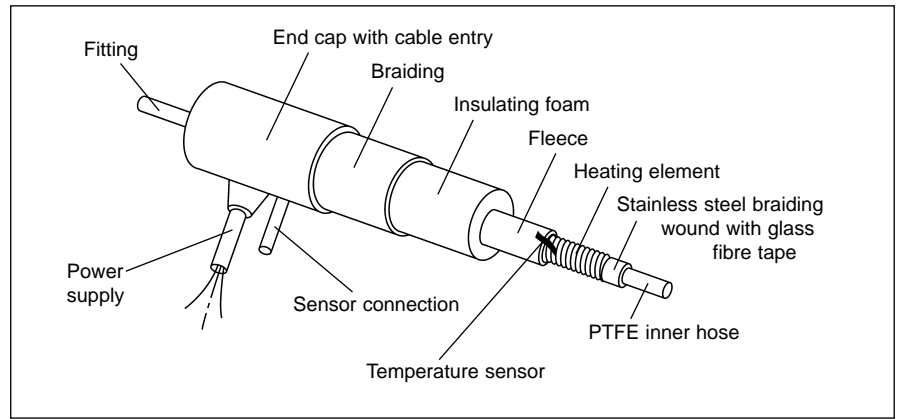

### Design of the heated hose

- The design of the heating conductor meets the requirements of the VDE Directives, i.e. it is moisture-proof and equipped with a PE protective braiding.
- The heated hose's technical construction does not cause any substantial limitation of the high flexibility of the inner hose.

Thermal insulation is selected on the basis of the nominal temperature. For instance, a closed cell polyurethane foam insulation would be selected for a nominal temperature of 100°C, whereas closed cell silicone foam with a temperature stabilization would be the insulation of choice in the case of nominal temperatures from 100°C to 250°C. The thickness of the insulation

is selected to match the basic data of the safety regulations applicable to the device. From 250°C up to 380°C, an insulation material with an extremely high temperature resistance will be used which we have proven to meet these high standards.

Owing to the poor mechanical load characteristics of the thermal insulation materials used, the insulation is protected from mechanical damage by a protective over-braid or outer jacket, respectively.

The end of each heated hose systems is formed by end caps which are generally made from silicone rubber. In the case of extremely low or high temperatures, different materials may be used as well.

### PTFE inner hose with increased pressure resistance

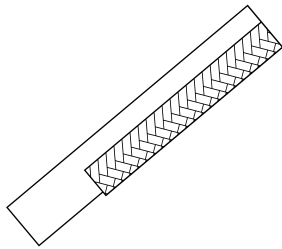

T 1 = One braided layer of DIN 1.4301 stainless steel wire

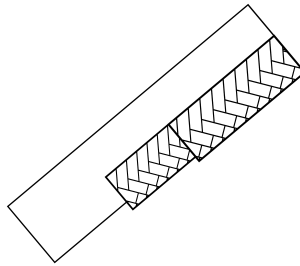

T 2 = Two braided layers of DIN 1.4301 stainless steel wire

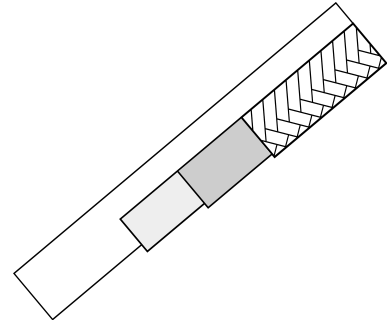

T 3 = Two wrapped and one braided layer of DIN 1.4301 stainless steel wire

## Notes on technical rating

### 1. The nominal diameter

To avoid unnecessary pressure losses or the need of using reducing fittings for adaptation, the selected nominal diameter (ND) should match the specifications of the plant. Please note that the heated hose's ND is not identical with the interior diameter of the fitting (pressure load). Upon request, however, this can be implemented for non-pressurized operation using the RLS type fitting. Please compare the technical details given in our tables to the specs of your plant.

### 2. The fitting

Considering that the PTFE inner hose is resistant to almost all media, the selection of the fitting material will be important with regard to the possible application of the heated hose system. In this context it has to be verified in each individual case whether the selected material is resistant to the medium to be conveyed. In addition to the standard materials used, i.e. galvanised steel and stainless steel, it is also possible to use special materials such as brass, Hastelloy, PTFE, etc.

Similar attention should be paid to the specification of the thread. In many cases the corresponding information can be found in the description of the plant. If this is not the case, please use an adapter piece to check the thread type. Check and see that the adapter piece can be fully screwed into the thread. In case of doubt, compare the available data in our fittings dimensional tables.

### 3. Technical design of the heated hose

The technical design of the heated hose is determined by the operating temperature and possible product temperature peaks. These details are also important for the initial operation of the device.

#### PLEASE NOTE:

Increasing temperatures will reduce the pressure resistance of the basic hose.

### 4. Pressure load

Each plant uses a predetermined operating pressure. Nonetheless, temporary pressure peaks may occur. These pressure peaks may be very high and lead to the destruction of the heated hose if they prevail over extended periods of time. It is therefore important to match the heated hose to the max. operating pressure.

### 5. Electrical power

Based on empirical data, one particular standard wattage was determined for each nominal width, and this wattage value is used as a reference for power rating for the individual standard heated hose types. For special applications, however, it is also possible to determine product related wattages, or to use customer supplied specifications as a reference value.

The pressure table on page 6 will provide you with an overview of the admissible operating pressures of the individual nominal hose widths as a function of the operating temperature.

### 6. Temperature sensor

The standard temperature sensor used on the heated hoses is an FeCuNi J type sensor. But other sensors (for example Pt 100 or NiCr-Ni K type) may be used at any time if you are already using control equipment which does not correspond to our standard programme. For project planning, however, the designation and technical data of the temperature sensor have to be stated in each case.

**Pressure table and bending radiuses for heated hoses  
of the IHH 105, IHH 203, and IHH 205 types**

ND	Bending radius With a braiding length of (T1)* mm	Operating pressure								
		at 24°C			at 100°C			at 200°C**		
		T1 bar	T2 bar	T3 bar	T1 bar	T2 bar	T3 bar	T1 bar	T2 bar	T3 bar
4	200	275	--	--	260	--	--	228	--	--
6	200	240	275	500	228	260	475	199	228	415
8	200	200	250	475	190	237	451	166	207	395
10	290	175	225	475	166	213	451	145	186	395
13	290	150	200	450	142	190	427	124	166	374
16	290	135	175	363	128	166	345	112	145	301
20	460	100	150	275	95	142	260	83	124	220
25	520	80	130	225	76	123	210	66	107	185
32	upon request	--	70	--	--	66	--	--	58	--
40	upon request	--	50	--	--	47	--	--	41	--
50	upon request	--	--	--	--	--	--	--	--	--

\* Bending radius with T2 and T3 upon request

\*\* At higher temperatures the strength will drop down to 0 bar.

### 7. Electrical connections

In addition to the power supply connection of the heating, other control lines are often required to supply voltage to additional devices. These lines may be integrated inside the hose so that no extra cost is to be incurred for subsequent installation work. In such a case please indicate the desired number of cores and the power rating of these devices.

The connection lines for heating, temperature sensor, and control lines may be grouped or arranged separately. Please tell us your wishes in this respect.

### 8. Electrical plug-in connections

A number of plug type connectors are included in our standard offer. Please feel free to specify the make and type of other plug connectors. If you do not know the relevant data, please send us a sample. Please do not forget to identify the channel assignment, otherwise proper functioning will not be possible.

**PLEASE NOTE:**

An incorrect assignment of the plug channels may lead to the destruction of the heated hose!

### 9. Outer overbraid/jacket

The selection and use of the outer overbraid or jacket are determined by the mechanical and thermal load circumstances. Your specifications will be taken into account in each case, otherwise we will suggest an appropriate alternative.

### 10. Temperature controlling equipment

A wide selection of temperature control equipment covering all temperature ranges is available for the heated hoses. The quality of the controller is essential with regard to the accuracy of the product temperature to be maintained, the quality of your product, and the lifetime of the heated hose. An improper selection of the heating and control equipment will lead to operational disturbances and always involves costs.

### Combining multiple short hose lengths over longer distances

If you need to cover longer distances, you can couple a number of short heated hoses including the required power supply lines. The electrical connection is made using special plugs/couplings meeting the requirements of the IP 65 type of protection.

#### KKS/36 and KKS/42 coupling boxes

The coupling boxes of the KKS/36 or KKS/42 type are used to join various hose lengths equipped with PG 36 or PG 42 thread connectors. For thermal insulation at these junction points, the boxes are fitted with a heat insulation.

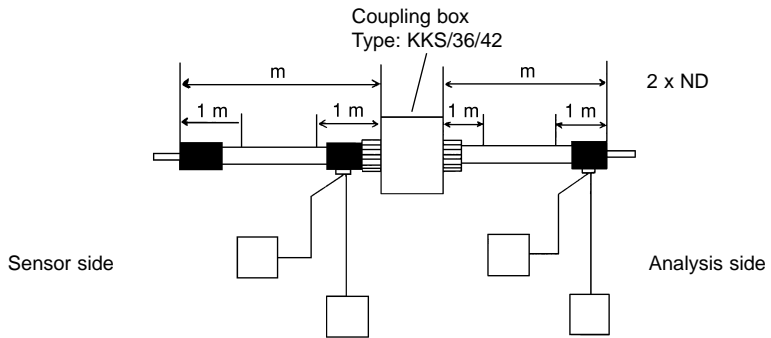
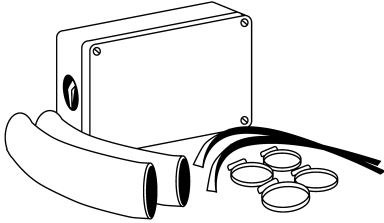

#### PK 500 junction kit

Another possibility of connecting hoses is provided by the use of a junction nipple (for connection to a spherical socket according to DIN 3863). To prevent thermal loss at the point of junction, it is insulated by a jacket (heated or non-heated).

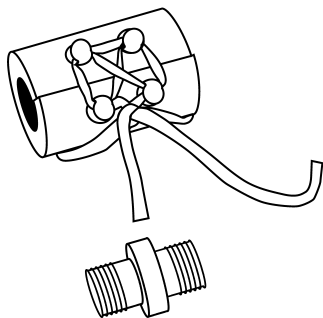

IHH 105

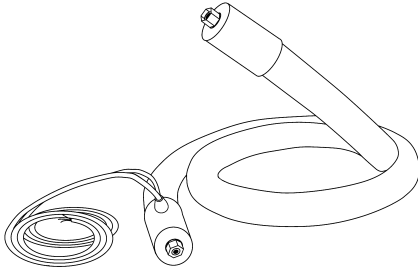

Special designs:

Upon request, the hoses are available in other lengths, with different power ratings and connection fittings or temperature sensors, or for higher pressures.

**Specification**

Temperature	100°C max.
Type of basic hose	PTFE hose with one layer of stainless steel braiding (T1)
Connection fitting	DKR: Universal sealing cone ISO 228/1 union nut, galvanised steel
Heating conductor	With protective braiding
Protection class	I
System of protection	IP 65, hoseproof (low pressure)
Temperature sensor	Fe-CuNi, J type
Thermal insulation	Heat stabilised closed cell polyurethane foam
Outer protection	Polyamide braiding, orange (140°C max.)
Power supply and sensor line	1.5 m without plug
Hose end caps	Silicone with strain relief and anti-kink protection
Nominal voltage	230 V
Test voltage	1500 V high-voltage test, heating conductor - earth

**Tolerances**

Heating power	+/- 10 %
Diameter	+/- 10 %
Length in ms	+/- 5 %

**Examples from our standard range** (more types upon request)

Nominal diameter	6 mm	8 mm	10 mm
Inner diameter of inner hose	6,4 mm	8,1 mm	10,5 mm
Outer diameter of inner hose	10,0 mm	11,8 mm	14,0 mm
Inner fitting diameter (D <sub>1</sub> )	4,5 mm	6,0 mm	7,5 mm
Outer fitting diameter (D <sub>2</sub> )	G 1/4"	G 3/8"	G 3/8"
Operating pressure at 24°C *	240 bar	200 bar	175 bar
Power	110 W/m	130 W/m	150 W/m
Bending radius	> 200 mm	> 200 mm	> 200 mm

Length (m)	Part No.		
1,0	314 222-000	411 488-000	122 894-000
2,0	643 498-000	726 040-000	635 486-000
3,0	216 596-000	584 384-000	951 668-000
4,0	703 118-000	685 826-000	437 164-000
5,0	102 370-000	580 882-000	940 056-000

\* Correction factor for operating pressure:

24°C	≤ 100°C
1,0	0,95

IHH 203

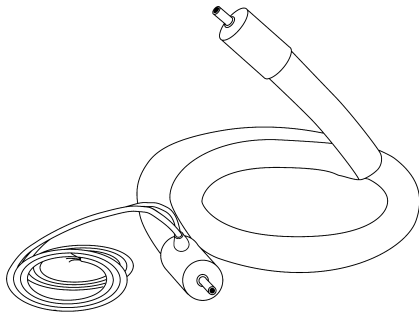

**Special designs:**

Upon request, the hoses are available in other lengths, with different power ratings and connection fittings or temperature sensors, or for higher pressures.

**Specification**

Temperature	200°C max.
Type of basic hose	PTFE hose with one layer of stainless steel braiding (T1)
Connection fitting	RSL; Pipe socket, light duty series, suitable for olive and union nut according to DIN 3861 / 3870 V2A 1.4305
Heating conductor	With protective braiding
Protection class	I
System of protection	IP 65, hoseproof (low pressure)
Temperature sensor	Fe-CuNi, J type
Thermal insulation	Heat stabilised closed cell silicone hose
Outer protection	Polyamide braiding, grey (140°C max.)
Power supply and sensor line	1.5 m without plug
Hose end caps	Silicone with strain relief and anti-kink protection
Nominal voltage	230 V
Test voltage	1500 V high-voltage test, heating conductor - earth

**Tolerances**

Heating power	+/- 10 %
Diameter	+/- 10 %
Length in ms	+/- 5 %

**Examples from our standard range** (more types upon request)

Nominal diameter	4 mm	6 mm
Inner diameter of inner hose	4,8 mm	6,4 mm
Outer diameter of inner hose	8,2 mm	10,0 mm
Inner fitting diameter (D <sub>1</sub> )	3,0 mm	4,5 mm
Outer fitting diameter (D <sub>2</sub> )	6,0 mm	8,0 mm
Operating pressure at 24°C *	275 bar	240 bar
Power	90 W/m	110 W/m
Bending radius	> 200 mm	> 200 mm

Length (m)	Part No.	
1,0	131 840-000	583 468-000
2,0	163 572-000	690 214-000
3,0	800 848-000	747 278-000
4,0	877 536-000	149 734-000
5,0	543 908-000	952 546-000

\* Correction factor for operating pressure:

24°C	≤ 100°C	≤ 150°C	≤ 200°C
1,0	0,95	0,90	0,83

IHH 205

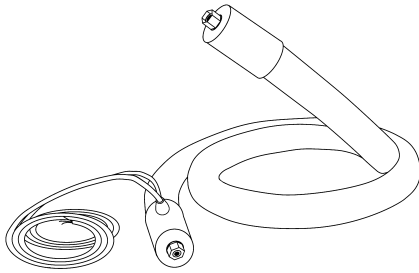

Special designs:

Upon request, the hoses are available in other lengths, with different power ratings and connection fittings or temperature sensors, or for higher pressures.

**Specification**

Temperature	100°C max.
Type of basic hose	PTFE hose with one layer of stainless steel braiding (T1)
Connection fitting	DKR: Universal sealing cone ISO 228/1 union nut, galvanised steel
Heating conductor	With protective braiding
Protection class	I
System of protection	IP 65, hoseproof (low pressure)
Temperature sensor	Fe-CuNi, J type
Thermal insulation	Heat stabilised closed cell silicone hose
Outer protection	Polyamide braiding, grey (140°C max.)
Power supply and sensor line	1.5 m without plug
Hose end caps	Silicone with strain relief and anti-kink protection
Nominal voltage	230 V
Test voltage	1500 V high-voltage test, heating conductor - earth

**Tolerances**

Heating power	+/- 10 %
Diameter	+/- 10 %
Length in ms	+/- 5 %

**Examples from our standard range** (more types upon request)

Nominal diameter	6 mm	8 mm
Inner diameter of inner hose	6,4 mm	8,1 mm
Outer diameter of inner hose	10,0 mm	11,8 mm
Inner fitting diameter (D <sub>1</sub> )	4,5 mm	6 mm
Outer fitting diameter (D <sub>2</sub> )	G 1/4"	G 3/8"
Operating pressure at 24°C *	240 bar	200 bar
Power	110 W/m	130 W/m
Bending radius	> 200 mm	> 200 mm

Length (m)	Part No.	
1,0	151 820-000	356 298-000
2,0	982 752-000	560 000-000
3,0	089 436-000	944 132-000
4,0	214 910-000	338 894-000
5,0	003 576-000	744 654-000

\* Correction factor for operating pressure:

24°C	≤ 100°C	≤ 150°C	≤ 200°C
1,0	0,95	0,90	0,83

### Examples

Other fittings available for IHH 105, IHH 203, and IHH 205

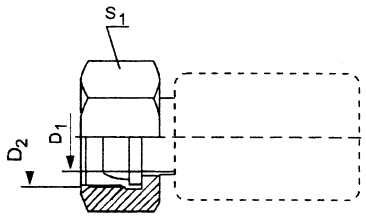

#### DKL

Universal sealing cone, light duty series, for 24° mating DIN 20078 connector

ND	D <sub>1</sub>	D <sub>2</sub>	S <sub>1</sub>	To pipe OD
3	2,0 mm	M 12 x 1,5	14	6 mm
4	3,0 mm	M 12 x 1,5	14	6 mm
6	4,5 mm	M 14 x 1,5	17	8 mm
8	6,0 mm	M 16 x 1,5	19	10 mm
10	7,5 mm	M 18 x 1,5	22	12 mm
13	10,0 mm	M 22 x 1,5	27	15 mm
16	12,5 mm	M 26 x 1,5	32	18 mm
20	16,0 mm	M 30 x 2,0	36	22 mm
25	20,5 mm	M 36 x 2,0	41	28 mm
32	27,0 mm	M 45 x 2,0	50	35 mm
40	33,0 mm	M 52 x 2,0	60	42 mm

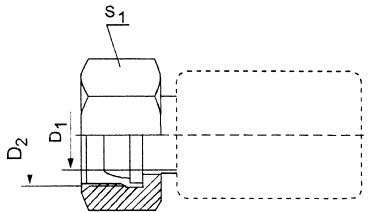

#### DKR

Universal sealing cone, ISO 228/1 union nut

ND	D <sub>1</sub>	D <sub>2</sub>	S <sub>1</sub>
3	2,0 mm	G 1/4"	17
4	3,0 mm	G 1/4"	17
6	4,5 mm	G 1/4"	17
8	6,0 mm	G 3/8"	19
10	7,5 mm	G 3/8"	19
10	7,5 mm	G 1/2"	24 / 27
13	10,0 mm	G 1/2"	24 / 27
16	12,5 mm	G 3/4"	32
20	16,0 mm	G 1"	41
25	20,5 mm	G 1"	41
25	20,5 mm	G 1 1/4"	50
32	27,0 mm	G 1 1/4"	50
40	33,0 mm	G 1 1/2"	56
50	44,0 mm	G 2"	70

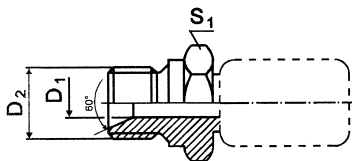

#### AGR

Nipple with external thread, 60° cone, ISO 228/1

ND	D <sub>1</sub>	D <sub>2</sub>	S <sub>1</sub>
4	2,5 mm	G 1/8"	14
6	4,5 mm	G 1/4"	17 / 18
8	6,0 mm	G 3/8"	19 / 22
10	7,0 mm	G 3/8"	22
10	7,5 mm	G 1/2"	22
13	10,0 mm	G 1/2"	27
16	12,5 mm	G 3/4"	32
20	16,0 mm	G 3/4"	32
20	16,0 mm	G 1"	36
25	20,5 mm	G 1"	38 / 41
32	27,0 mm	G 1 1/4"	50
40	33,0 mm	G 1 1/2"	55
50	44,0 mm	G 2"	70

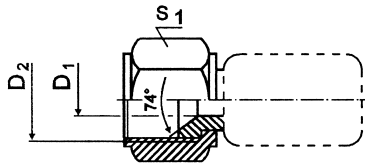

DKJ

74° JIC sealing head  
UNF union nut

ND	D <sub>1</sub>	D <sub>2</sub>	S <sub>1</sub>
6	4,5 mm	UNF 7/16 - 20	14
6	4,5 mm	UNF 1/2 - 20	17
6	4,5 mm	UNF 9/16 - 18	17
8	6,0 mm	UNF 9/16 - 18	17
10	7,5 mm	UNF 3/4 - 16	22 / 24
13	10,0 mm	UNF 3/4 - 16	22 / 24
13	10,0 mm	UNF 7/8 - 14	27 / 32
16	12,5 mm	UNF 7/8 - 14	27 / 32
16	12,5 mm	UNF 1 1/16 - 12	32
20	16,0 mm	UNF 1 1/16 - 12	32
25	20,5 mm	UNF 1 5/16 - 12	41
32	27,0 mm	UNF 1 5/8 - 12	51
40	33,0 mm	UNF 1 7/8 - 12	56

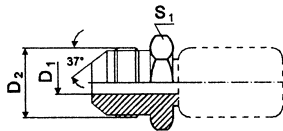

AGJ

JIC nipple with external thread  
UNF

ND	D <sub>1</sub>	D <sub>2</sub>	S <sub>1</sub>
6	4,5 mm	UNF 7/16 - 20	14
6	4,5 mm	UNF 1/2 - 20	14
8	6,0 mm	UNF 1/2 - 20	14
8	6,0 mm	UNF 9/16 - 18	17
10	7,5 mm	UNF 9/16 - 18	18
13	10,0 mm	UNF 3/4 - 16	22
16	13,0 mm	UNF 7/8 - 14	26
20	16,0 mm	UNF 1 1/16 - 12	32
25	20,5 mm	UNF 1 5/16 - 12	36
32	27,0 mm	UNF 1 5/8 - 12	46
40	33,0 mm	UNF 1 7/8 - 10	48

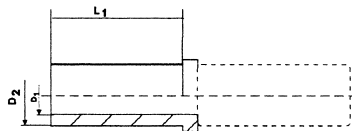

RSL

Pipe socket, light duty series.  
Olive and union nut  
(DIN 3861 / 3870) not supplied.

ND	D <sub>1</sub>	D <sub>2</sub>	L <sub>1</sub>	To pipe OD
3	2,0 mm	6 mm	25 mm	6 mm
4	3,0 mm	6 mm	25 mm	6 mm
6	4,5 mm	8 mm	25 mm	8 mm
8	6,0 mm	10 mm	26 mm	10 mm
10	7,5 mm	12 mm	26 mm	12 mm
13	10,0 mm	15 mm	28 mm	15 mm
16	12,5 mm	18 mm	30 mm	18 mm
20	16,0 mm	22 mm	32 mm	22 mm
25	20,5 mm	28 mm	30 mm	28 mm
32	27,0 mm	35 mm	36 mm	35 mm
40	33,0 mm	42 mm	36 mm	42 mm

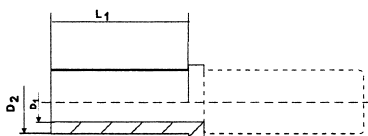

RSS

Pipe socket, heavy duty series.  
Olive and union nut  
(DIN 3861 / 3870) not supplied.

ND	D <sub>1</sub>	D <sub>2</sub>	L <sub>1</sub>	To pipe OD
4	3,0 mm	8 mm	27 mm	8 mm
6	4,0 mm	10 mm	29 mm	10 mm
8	6,0 mm	12 mm	29 mm	12 mm
10	7,5 mm	14 mm	33 mm	14 mm
13	9,5 mm	16 mm	33 mm	16 mm
16	12,5 mm	20 mm	39 mm	20 mm
20	16,0 mm	25 mm	44 mm	25 mm
25	20,5 mm	30 mm	48 mm	30 mm
32	27,0 mm	38 mm	55 mm	38 mm

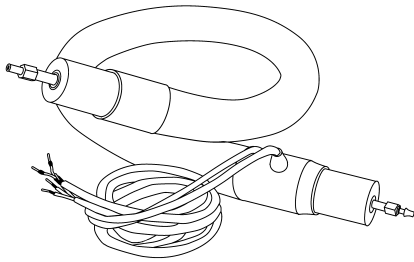
**IHH 380**

**Special designs:**

Upon request, the hoses are available in other lengths, with different power ratings and connection fittings or temperature sensors, or for higher pressures.

**Specification**

Temperature	380°C max.
Type of basic hose	Corrugated metal hose 1.4571 (T1)
Connection fitting	FL; steel pipe socket, light duty series, cutting-ring socket
Heating conductor	NiCr heating conductor with electrical insulation
Protection class	I
System of protection	IP 65, hoseproof (low pressure)
Temperature sensor	NiCr-Ni (optional Pt 100 or Fe-CuNi)
Thermal insulation	High thermoresistant mineral insulation material
Outer protection	Outer protective braid high-grade steel 1.4541 (200°C max.)
Power supply and sensor line	1.5 m without plug
Hose end caps	Silicone with strain relief and anti-kink protection
Nominal voltage	230 V
Test voltage	1500 V high-voltage test, heating conductor - earth

**Tolerances**

Heating power	+/- 10 %
Diameter	+/- 10 %
Length in ms	+/- 5 %

Length (m)	Order number
1,0	966 646-000
2,0	003 918-000
3,0	612 164-000
4,0	792 630-000
5,0	767 080-000

**Examples from our standard range** (more types upon request)

Nominal diameter	6 mm
Inner diameter of inner hose	6 mm
Outer diameter of inner hose	11,5 mm
Inner fitting diameter (D <sub>1</sub> )	6 mm
Outer fitting diameter (D <sub>2</sub> )	8 mm
Operating pressure at 24°C *	125 bar
Power	160 W/m
Bending radius	> 500 mm

**Thermal reduction factors k<sub>t</sub> \***

Operating temperature °C	Material Metal hose AISI 321 1.4541
20	1,00
100	0,86
150	0,82
200	0,76
250	0,72
300	0,67
350	0,64

**Dynamic reduction coefficients k<sub>d</sub> \***

Vibrations Motion	none slight, slow	slight frequently, uniform	strong permanent motion
Static or slow, uniform flow	1,00	0,82	0,40
Pulsating and surging flow	0,80	0,65	0,33
Rhythmic and shock-wise flow	0,40	0,35	0,15
Highly shock-wise flow	0,30	0,20	0,10

\* The operating pressure is calculated as follows: Operating pressure = (operating pressure at 24°C) x k<sub>d</sub> x k<sub>t</sub>

### Examples

Further fittings available for the IHH 380 heated hose

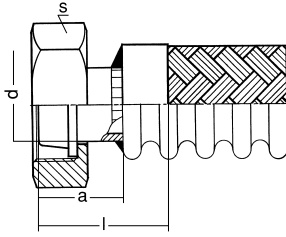

#### AFL

Union nut and sealing cone  
made of steel, light duty series

ND	a	d	s	l
4	20 mm	M 12 x 1,5	14 / 17	40
6	20 mm	M 14 x 1,5	17	40
8	22 mm	M 16 x 1,5	19	42
10	22 mm	M 18 x 1,5	22	42
13	25 mm	M 22 x 1,5	27	45
16	25 mm	M 26 x 1,5	32	45
20	25 mm	M 30 x 2,0	36	45
25	30 mm	M 36 x 2,0	41	50
32	32 mm	M 45 x 2,0	50 / 55	52
40	40 mm	M 52 x 2,0	60	60

If soldered, max. useful temperature 350°C; if welded, this temp. can be higher.

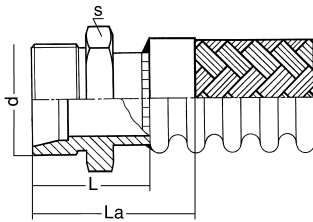

#### HL

Threaded steel nipple with external  
thread for cutting-ring connection,  
light duty series

ND	L	d	s	La
4	22 mm	M 12 x 1,5	12	42
6	23 mm	M 14 x 1,5	14	43
8	25 mm	M 16 x 1,5	17	45
10	25 mm	M 18 x 1,5	19	45
13	29 mm	M 22 x 1,5	24	49
16	31 mm	M 26 x 1,5	27	51
20	36 mm	M 30 x 2,0	32	56
25	38 mm	M 36 x 2,0	41	58
32	43 mm	M 45 x 2,0	46	53
40	46 mm	M 52 x 2,0	55	56

If soldered, max. useful temperature 350°C; if welded, this temp. can be as high as 600°C max.

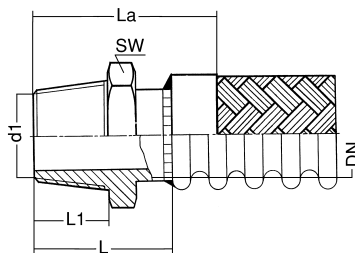

#### HN

Threaded steel nipple with external  
thread according to DIN 2999

ND	L1	L	d1	SW	La
4	8 mm	22 mm	1/8"	13	42
6	12 mm	26 mm	1/4"	17	46
8	12 mm	26 mm	1/4"	17	46
10	12 mm	28 mm	3/8"	22	48
13	14 mm	44 mm	1/2"	27	64
16	14 mm	44 mm	1/2"	27	64
20	16 mm	47 mm	3/4"	32	67
25	18 mm	53 mm	1"	41	73
32	20 mm	57 mm	1 1/4"	50	77
40	22 mm	59 mm	1 1/2"	55	79
50	24 mm	68 mm	2"	70	88
65	27 mm	75 mm	2 1/2"	85	95
80	30 mm	83 mm	3"	100	123
100	36 mm	95 mm	4"	130	135
125	41 mm	118 mm	5"	150	158
150	41 mm	118 mm	6"	180	158

Malleable iron possible up to 300°C.

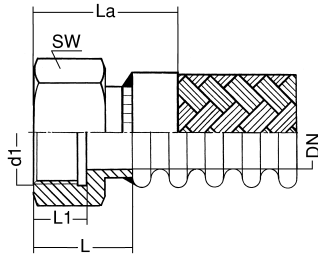

**IR**

Screw socket with internal thread according to DIN 2999

ND	L1	L	d1	SW	La
4	10 mm	25 mm	1/8"	13	45
6	12 mm	27 mm	1/4"	17	47
8	12 mm	27 mm	1/4"	17	47
10	12 mm	30 mm	3/8"	22	50
13	14 mm	36 mm	1/2"	27	56
16	14 mm	36 mm	1/2"	27	56
20	16 mm	39 mm	3/4"	32	59
25	18 mm	45 mm	1"	41	65
32	20 mm	50 mm	1 1/4"	50	70
40	22 mm	55 mm	1 1/2"	55	75
50	24 mm	65 mm	2"	70	85
65	27 mm	74 mm	2 1/2"	85	94
80	30 mm	80 mm	3"	100	120
100	36 mm	94 mm	4"	130	134
125	40 mm	109 mm	5"	150	149
150	40 mm	120 mm	6"	180	160

Malleable iron possible up to 300°C.

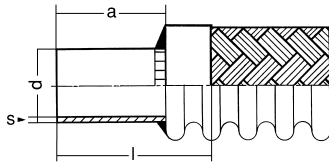

**FL**

Steel pipe socket, light duty series. Olive and union nut not supplied.

ND	a	d	s	l
4	25 mm	6 mm	1 mm	45
6	30 mm	8 mm	1 mm	50
8	30 mm	10 mm	1 mm	50
10	30 mm	12 mm	1 mm	50
13	32 mm	15 mm	1,5 mm	52
16	32 mm	18 mm	1,5 mm	52
20	36 mm	22 mm	1,5 mm	56
25	40 mm	28 mm	2 mm	60
32	45 mm	35 mm	2 mm	65
40	45 mm	42 mm	2 mm	65

If soldered, max. useful temperature 350°C; if welded, this temp. can be as high as 600°C max.

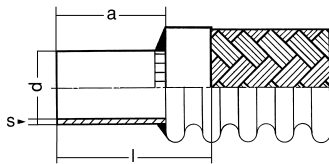

**FS**

Steel pipe socket, heavy duty series. Olive and union nut not supplied.

ND	a	d	s	l
4	30 mm	8 mm	1 mm	50
6	30 mm	10 mm	1 mm	50
8	30 mm	12 mm	1 mm	50
10	35 mm	14 mm	1,5 mm	55
13	35 mm	16 mm	1,5 mm	55
16	40 mm	20 mm	2 mm	60
20	45 mm	25 mm	2 mm	65
25	50 mm	30 mm	2,5 mm	70
32	55 mm	38 mm	3 mm	75

If soldered, max. useful temperature 350°C; if welded, this temp. can be as high as 600°C max.

## Heated hoses for gas analysis

Heated hoses for flue-gas analysis sampling are manufactured in standard nominal diameters from 4 mm to 10 mm.

The multitude of requirements imposed on the heated hoses calls for a number of additional options such as:

- Integrated stainless steel carrying cable for strain relief if the hose is to be laid over longer distances
- Integration of supply and control lines within the hose
- Electrical and mechanical interconnection of multiple hoses
- Additional temperature sensors, for example for temperature limitation
- Multi-channel plugs matching our controlling and regulating units

### IHH - oD series

Non-pressurized, with fixed inner hose;

### IHH - oDT series

Non-pressurized, with fixed inner hose, non-crushable outer jacket (Anaconda);

### IHH - oDi series

Non-pressurized, with replaceable inner hose;

### IHH - oDiT series

Non-pressurized, with replaceable inner hose, non-crushable outer jacket (Anaconda);

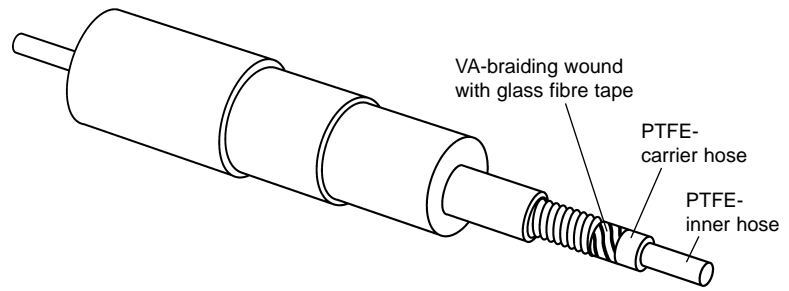

## Specification

Temperature	Optional	• Up to 100°C • Up to 200°C
Type of basic hose		PTFE carrier hose with one layer of stainless steel braiding
Inner hose		PTFE inner hose, 500 mm projecting length at both ends, Optional
Connection with fitting	Optional	• <b>Replaceable or Fixed</b> • Pipe nipple according to DIN 3861, 1.4305 / 1.4541 stainless steel • PG 36 threaded plastic or steel connector
Connection without fitting	Optional	• PTFE inner hose • Carrier hose
Heating conductor		With protective braiding
System of protection		IP 65, hoseproof (low pressure)
Temperature sensor	Optional	• Fe-CuNi • NiCr-Ni • Pt 100
Thermal insulation	Optional	• Fleece materials • PUR foam up to 100°C • Heat-stabilised closed Si foam hose 100°C to 200°C
Outer protection	Optional	• Polyamide braiding, (140°C max.) • Steel braiding, galvanized, or VA 1.4541 (200°C max.) • Plastic corrugated hose (80°C max.) • Non-crush design, Anaconda (70°C max.)
Hose length		50 m max., depending on nominal diameter
Power supply and sensor connection line		1.5 m without plug
Hose end caps		Silicone with strain relief and anti-kink protection
Nominal voltage		230 V
Test voltage		1500 V
Heating output		Gradual depending on nominal diameter

## Pressure behaviour of the PTFE inner hose

Temperature up to	20°C	100°C	200°C	250°C
With 4 mm / 6 mm diameter	10 bar	5 bar	3 bar	2 bar
With 6 mm / 8 mm diameter	4 bar	2 bar	1 bar	0 bar

## Connection accessories

Coupling box	KKS/36 or KKS/42 type
--------------	-----------------------

**IHA**  
**heated hoses in cut to length design**

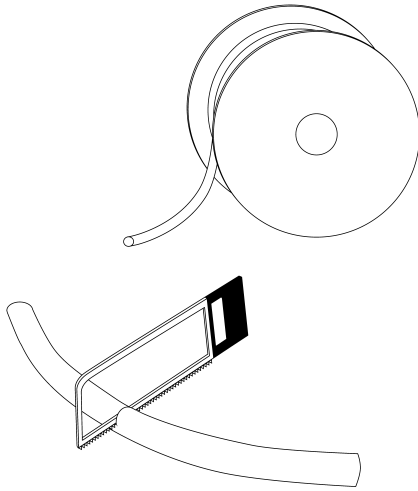

For applications in which you need to cut an accurately required length of heated hose off the reel on site, we have designed the non-pressurized heated hoses for use in the temperature range up to 100°C.

These heated hoses in cut to length design can be used:

- as an anti-freeze line (+5°C) for water analysis in water treatment plants or other types of analyses in process technology.
- in environmental technology, for example for emission measurement in power plants, industrial firing plants, and garbage incineration plants.

	IHA-SL10	IHA-P 30
<b>Specification</b>		
Type of basic hose	PTFE extruded	PTFE extruded
Nominal diameter		
- Inner diameter of inner hose	6	6
- Outer diameter of inner hose	8	8
Heating		
- Self-regulating heating tape	10 W/m	
- FEP parallel heating tape		30 W/m
Length per heating zone: 1 m		
Max. admissible operating temperature		
- With heating on	65°C	150°C
- Intermittent, with heating off	85°C	205°C
Thermal insulation	Fleece	Aluminium foil, Fleece
Outer PVC jacket (colour: black)		
- Outer diameter	30 mm	30 mm
- Temperature range	-20 to +65°C	-20 to +65°C
Max. bending radius	Fixed	200 mm
Max. heated hose length	150 m	75 m
<b>Ordering details</b>		
Part description	<b>IHA-SL 10</b>	<b>IHA-P 30</b>
Part No. (per running meter)	154 338-000	656 850-000
<b>Accessories</b>		
<b>Termination set</b>		
Part description	TSL5	THTS
Part No.	666 640-000	721 482-000
<b>Pt 100 temperature sensor</b>		
Part description	TAI-PM	TAI-PM
Part No.	068 430-000	068 430-000
<b>Fe-CuNi temperature sensor</b>		
Part description	TAI-FM	TAI-FM
Part No.	205 360-000	205 360-000
<b>Connection box</b>		
Part description	KG 5	KG 5
Part No.	011 066-000	011 066-000

**Benefits of the heated hoses in cut to length design**

- Can be cut off from the reel.
- No accurate pre-measuring required.
- The special design and connection technology ensures easy and convenient termination and installation on site.
- Gaseous media are transferred without temperature loss from the sampling point to the analytical device.



<p><b>Specification heated hoses</b></p> <p>Company: .....</p> <p>.....</p> <p>.....</p> <p>.....</p> <p>Clerk/Engineer in charge: .....</p> <p>Tel.: ..... Fax: .....</p> <p>Email: .....</p>	<p>Fax to:</p> <p><b>Tyco Thermal Controls</b>          Parkside, Wadham Street          Weston-super-Mare          GB-North Somerset, BS23 1JY          Phone: +44(0)1934-629273          Fax: +44(0)1934-626125          Email: rgunning@tycothermal.com</p>
--	--

Description	Remarks
Range of application	<input type="radio"/> outdoor <input type="radio"/> indoor <input type="radio"/> ex range <input type="radio"/> non-ex range
Medium	<input type="radio"/> liquid <input type="radio"/> gaseous
Min. ambient temperature	°C
Max. admissible media temperature	°C
Max. ambient temperature	°C
Operating temperature	°C
Length of heated hose	m
Inner diameter of heated hose	NW: <input type="radio"/> replaceable basic hose
Voltage	Volt
Power / per metre	Watt
Earth lead	<input type="radio"/> yes <input type="radio"/> no     <input type="radio"/> Heating conductor with protective braiding
Hoseproof (low pressure)	<input type="radio"/> yes <input type="radio"/> no     <input type="radio"/> Corrugated hose
PTFE basic hose with	layer(s) of stainless steel braiding
Operating pressure	bar
Outer diameter of the heated hose	mm
Outer diameter of the end cap	mm
Hose fittings	one end (e.g. DKR G 1/2"): other end (e.g. RSL-13):
Type of thread	<input type="radio"/> metric <input type="radio"/> inch <input type="radio"/> other
Outer protection	<input type="radio"/> PA braiding <input type="radio"/> V2A braiding <input type="radio"/> Corrugated hose <input type="radio"/> Other (e.g. non-crush)
Length of power line	m    (standard 1.5 m)
Plug	<input type="radio"/> with <input type="radio"/> without       Type:
Integrated control line	<input type="radio"/> yes <input type="radio"/> no
Multi-channel plug	(e.g. AMP 6 + 1)
Temperature sensor	(e.g. Pt 100)
Length of sensor line	m    (standard 1.5 m)
Diode plug	<input type="radio"/> yes <input type="radio"/> no
Temperature limiter set to	°C
Brief description of range of application:	



Tyco Thermal Controls Product range contains a vast array of industrial heat tracing products to suit all applications. For more information order our speciality brochures and datasheets:

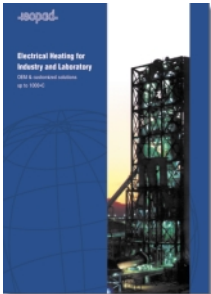

**Isopad**  
OEM & Customized Solutions



**Isopad**  
Heating Cables and Heating Tapes



**Isopad**  
Flexible Heaters



**Isopad**  
Heating Jackets

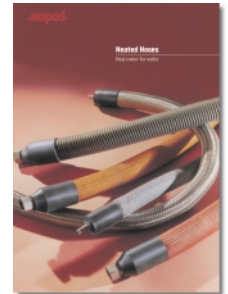

**Isopad**  
Heated Hoses



**Isopad**  
Mineral-Insulated Heating Cables and Radiant Heaters



**Isopad**  
Heating Systems\*



**Isopad**  
Temperature Control Systems



**Isopad**  
Laboratory Heating Mantles



**Isopad**  
Accessories

\* Complete solutions: Drum and gas bottle heaters, heating chambers, cold glue heaters, foot warming plates, antenna heaters

[www.isopad.de](http://www.isopad.de)  
[www.tycothermal.com](http://www.tycothermal.com)

Isopad – a brand of Tyco Thermal Controls.

*Important: All information, including illustrations, is believed to be reliable. Users, however, should independently evaluate the suitability of each product for their particular application. Tyco Thermal Controls makes no warranties as to the accuracy or completeness of the information, and disclaims any liability regarding its use. Tyco Thermal Controls' only obligations are those in the Tyco Thermal Controls Standard Terms and Conditions of Sale for this product, and in no case will Tyco Thermal Controls or its distributors be liable for any incidental, indirect or consequential damages arising from the sale, resale, use or misuse of the product. Specifications are subject to change without notice. In addition, Tyco Thermal Controls reserves the right to make changes, without notification to the Buyer, to processing or materials that do not affect compliance with any applicable specification.*



Tyco Thermal Controls GmbH  
Englerstraße 11  
D-69126 Heidelberg  
Phone +49(0)6221-3043-0  
Fax +49(0)6221-3043-956  
Info-Isopad-DE@Tycothermal.com

Tyco Thermal Controls N.V.  
Staatsbaan 4A  
B-3210 Lubbeek  
Phone +32(0)1621-3511  
Fax +32(0)1621-3600

Tyco Thermal Controls Limited  
3 Rutherford Road,  
Stephenson Industrial Estate,  
GB-Washington,  
Tyne and Wear NE37 3HX  
Phone +44(0)191 419 8200  
Fax +44(0)191 419 8201  
Info-Isopad-GB@Tycothermal.com

Worldwide Headquarters  
**Tyco Thermal Controls**  
300 Constitution Drive,  
Menlo Park,  
CA 94025-1164, USA  
Phone (800) 545-6258  
Fax (800) 596-5004  
Info-Isopad-US@Tycothermal.com

*We manage the heat you need*